

**Warewashing
 green&clean multi-rinse Rack Type,
 Energy Saving Device, ZERO LIME
 Device, electric, 200r/h, L>R**

ITEM # _____

MODEL # _____

NAME # _____

SIS # _____

AIA # _____

**535019
 (EMR20NELEW)**

Multi Rinse Rack Type Dishwasher, 200 racks/hour, electric, Left>Right, Energy Saving Device, medium pre-wash, constant rinse, self cleaning, ZERO LIME Device, CLEAR BLUE Filtering System, WASH-SAFE CONTROL, touch screen, variable speeds, insulated doors,

Short Form Specification

Item No. _____

Unit to be multi-rinse rack type dishwasher. Operating direction __ left to right or __ right to left. Featured built-in Energy Saving Device (ESD) recovers the heat inside the machine to heat up incoming cold water to the boiler. ZERO LIME device automatically de-scales the whole hydraulic circuit and all washing & rinsing chambers. Multi-rinse area with built-in Wash-Safe Control system and rinse booster pump guarantees constant rinse pressure. CLEAR BLUE filtering system removes majority of soil from the wash water to ensure clean water for long time. Included medium pre-wash zone works with cold water of max. 40°C. Maximum Water Contact (MWC) wash arms are positioned along the full length of the wash tank. Powerful wash pump and specially designed wash spray arms guarantee cleaning. Washing is done with water circulating at 55-65°C. Final rinsing is done with clean water heated up to 85°C that is re-used in several phases in pre-rinse at around 70°C. Multi-rinse with double rinse tanks and multi rinse arms re-uses rinsing water several times to ensure hygiene on washed wares. Constant 0.4 liter/rack rinse water consumption of cold water in any conveyor speed. Three conveyor speeds are selectable by the operator, one for maximum capacity, one compliant to DIN 10510 and one certified according to NSF/ANSI 3. Intuitive touch screen control panel provides easy communication on different levels. Easy drain of water done through control panel. Standard end of the day self cleaning cycle and sanitation cycle both including internal side of the door. Modularity allows split delivery, customization and upgrade on-site and over time.

Main Features

- CLEAR BLUE filtering system removes soil from the wash water providing cleaner water and highly active detergent thus ensuring better washing performance and lower running costs.
- Built-in WASH-SAFE CONTROL system raises water temperature to 85°C to sanitize the rinse water. No external boiler is required. Built-in air break and rinse booster pump ensure constant temperature and pressure throughout the rinsing cycle regardless of the inlet water condition.
- Deep drawn pressed wash tank with fully rounded corners, sloped towards the drain to prevent dirt build up provides fast drainage in only a few minutes. Pressed wash tank with no welded points offer a guaranteed water tight solution.
- Maximum capacity per hour of 200 racks easy to switch to DIN 10510 or NSF ANSI 3 compliant speed.
- Three conveyor speeds can be selected through the control panel by the operator and customized on site.
- Pre-wash section uses cold water so food remains are not "baked" onto the plates in order to have better pre-wash performance.
- Maximum Water Contact (MWC) wash arms are positioned along the full length of the wash tank.
- Multi-rinse arms in combination with double rinse tanks re-use final rinsing water in several phases to ensure hygiene and complete detergent removal on the washed wares.
- Built-in drain valve in the tanks allows automatic dump and fill to refresh the water in the tank without any interruption of the washing process.
- Intuitive touch screen control panel features user-friendly display to easily operate the machine and to monitor machine status. Three different levels of interaction are available each show relevant messages and information to the operator, the general maintenance staff and the authorized service partners.
- Automatic drain, clean and sanitize cycles featured as standard. The internal chambers, including the internal doors are completely cleaned or sanitized avoiding bacteria proliferation for maximum hygiene and reducing manual work/time for operator.
- Self-draining wash pumps provide maximum hygiene and all wash and rinse zones drain automatically at the push of a button.
- All internal components: wash and rinse arms, tank filters, curtains can be easily removed for cleaning.
- IP25 protection against water jets, solid objects and small animals (larger than 6 mm).
- Large counter balanced inspection doors allow unrestricted all-round access to the wash and rinse area. Door is insulated with injected foam. This adds strength as well as reduces noise and heat loss.
- Adjustable feet for full access underneath the machine for cleaning.
- Splashhood at the entrance avoids water spilling outside the machine.
- Unit equipped with USB port making it simple to

APPROVAL: _____



read data such as machine identification, counters and consumption, components, devices and alarm logs. Machine parameters can be uploaded and downloaded and firmware updated.

- Automatic back-up mode is activated when a failure occurs. Guided troubleshooting for fast fixes including 300 precises notifications and 23 easy-to-follow processes.

Construction

- Modularity design allows the machine not only be disassembled for delivery and re-assembled at customer's site, but also to be customized and upgraded on-site and over time.
- All main components made in heavy duty anti-corrosive 304 type stainless steel: external front, side panels and internal chambers, wash and rinse arms, doors and rack transportation system.
- Dishwasher structure is held together with a solid 50 x 50 mm stainless steel frame to provide long-term sturdiness.
- All electric components are put in one IP65 central box isolated from water and steam to ensure high reliability.
- External pre-arrangement for inlet water, drain water, detergent & rinse aid connections for fast and easy installation on both sides of the unit.
- The unit is built on modularity concept for easy to add pre-wash, wash and up to 2 dryer modules onsite.
- Table-to-table length, 2340mm.

Sustainability



- ZERO LIME Device as a fully automatic cycle ensures total scale removal from the boiler, the hydraulic circuit, the washing chamber and the rinsing chamber allowing ultimate performances and lower energy consumption thanks to highly efficient heating elements.
- Built-in Energy Saving Device (ESD) utilizes the hot steam generated by the machine in the rinse and wash tanks to heat up incoming cold water up to 55°C before entering the boiler, thus saving energy.
- Multi-rinse technology guarantees rinse water consumption of 0.4 liters/rack regardless of the conveyor speed to ensure low energy, water, detergent and rinse aid consumption.
- All chambers without internal pipes and therefore no hidden dirt traps.
- Auto-start/stop equipped in different zones ensures that the zone runs only when a rack is passing through it. This reduces water, energy, chemical consumption and noise.

Included Accessories

- 1 of Kit splash hood for rack type with ESD PNC 865280
- 1 of Kit delime for rack type PNC 865282

Optional Accessories

- Medium hot air blower zone without door for green&clean Multi Rinse Rack Type Dishwasher PNC 534056
- Medium pre-wash zone for green&clean Multi Rinse Rack Type Dishwasher with Energy Saving Device, ZERO LIME Device, WRAS/Watermark approval PNC 535036
- Large pre-wash zone for green&clean Multi Rinse Rack Type Dishwasher with Energy Saving Device, ZERO LIME Device, WRAS/Watermark approval PNC 535037
- Medium drying zone with door for green&clean Multi Rinse Rack Type Dishwasher PNC 535038
- Kit to adapt motorized table with green&clean Rack Type - Europe, UK, M.E., Africa, Asia, Latin America, Oceania PNC 865232
- Inclined extension table for roller conveyor PNC 865253
- Inclined extension table for splash hood PNC 865254
- Kit splash hood for rack type with ESD PNC 865280
- Kit to convert pre-wash module to wash module PNC 865281
- Kit water softener for Rack Type dishwasher PNC 865284
- Kit water meter PNC 865286
- Kit electronic connection for motorized table and remote pre-wash module PNC 865290
- Kit of splash panel to change on the splash hood for 90° and 180° curve table PNC 865291
- Lateral panel (to be used instead of splash hood on Rack Type with ESD) PNC 865489
- HACCP cable connection for Rack Type dishwasher PNC 865490
- Kit water softener and reverse osmosis for Rack Type Dishwasher PNC 865494
- Ethernet board (NIU-LAN) for green&clean Rack Type Dishwashers PNC 922696

Electric

Supply voltage:	
535019 (EMR20NELEW)	380-415 V/3N ph/50 Hz
Default Installed Power:	29.7 kW
Electrical power min:	22.7 kW
When the machine runs at DIN 10510 compliant speed.	
Energy consumption:	25.2 kWh
At average working conditions.	
Wash tank heating elements:	14 kW
Triple tank heating elements:	7 kW
Boiler heating elements:	5 kW
Wash pump size:	1.5 kW
Rinse pump size (final, duo, triple):	0.55 / 0.32 / 0.32 kW

Water:

Inlet water line size:	G 3/4"
Inlet cold water line size:	G 3/4"
Drain line size:	50mm
Inlet water supply pressure:	1.5-6 bar
Inlet water supply temperature (wash and rinse):	5 - 65°C
The higher the temperature, the faster the warm-up. Recommended temperature: 50°C.	
Inlet water supply temperature (rinse and pre-wash):	5 - 30 °C
Inlet water supply hardness:	0-14 °fH / 0-8°dH
When below 7°fH/4°dH special detergent and rinse aid are needed.	
Flow rate of wash pump:	500 l/h
Peak rate of drain flow:	1.8 l/s
Wash tank size:	70 l
Duo rinse tank size:	20 l
Triple rinse tank size:	20 l
Rinse water consumption:	

Key Information:

Productivity per hour (max. speed):	200 racks/3600dishes
Productivity per hour (DIN compliant speed):	148 racks/2664 dishes
Productivity per hour (NSF compliant speed):	130 racks/2340 dishes
Wash Temperature:	55 - 65 °C
Duo rinse temperature:	75-80 °C
Final rinse temperature:	85 °C
Triple rinse temperature:	70 - 75 °C
External dimensions, Width:	2640 mm
External dimensions, Depth:	895 mm
For transportation purpose only, the depth can be reduced to 795mm by removing the control box and the door handles.	
External dimensions, Height:	1785 mm
Height with door open:	2095 mm
Charging hole size (width):	530 mm
Charging hole size (height):	490 mm
Net weight:	500 kg
Shipping weight:	572 kg

Shipping height:	1980 mm
Shipping width:	1040 mm
Shipping depth:	3100 mm
Shipping volume:	6.38 m ³
Reference norm used to measure the noise: IEC60335-2-58 annex AA.	
Table to table distance:	2640 mm

Air Emission:

Air flow (top, exit):	86 / 145 m ³ /h
Air temperature:	27 - 45 °C
Air humidity (top, exit):	100 / 100 % r.h.
The data is measured at exhaust points at 25°C and 60% r.h. ambient conditions, 18°C inlet water temperature and refer only to the machine.	
Latent heat:	6900 W
Sensible heat:	4700 W
This model requires a ventilation hood. Please refer to the attached "Recommended Exhaust Hood Design".	

Sustainability

Rinse water consumption at max. speed:	80 l/h
Noise level:	<62 dBA



Front

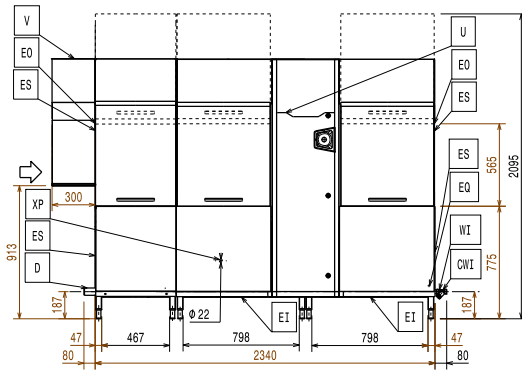

Side

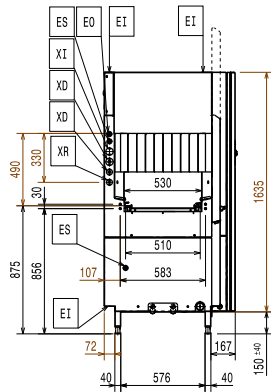

- CWI = Cold Water Inlet
- D = Drain
- EI = Electrical inlet (power)
- EO = Electrical Outlet
- EQ = Equipotential screw
- ES = Electrical signal IN/OUT
- HWI = Hot water inlet
- U = USB port
- WI = Water inlet

Top

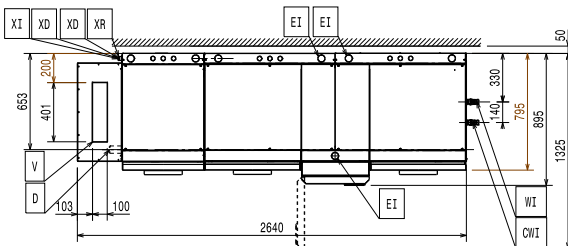

RECOMMENDED TABLE CONNECTION



⚠ Apply silicone between the machine and the table and make sure that there are not any water leakages.



All tables must be connected to the dishwashing units according to local regulations and industry standards which may differ from the recommendations herein suggested. Electrolux Professional is not liable for any failure in complying with local design standards.

RECOMMENDED HOOD DESIGN OPTIONS



All exhaust hoods must be dimensioned and installed according to local regulations and industry standards which may differ from the recommendations herein suggested. Electrolux Professional is not liable for any failure in complying with local design standards.

DOC. NO. 59566N500
EDITION 03.2017